

# DDR4 SDRAM Memory

---

## Product Guide

SAMSUNG ELECTRONICS RESERVES THE RIGHT TO CHANGE PRODUCTS, INFORMATION AND SPECIFICATIONS WITHOUT NOTICE.

Products and specifications discussed herein are for reference purposes only. All information discussed herein is provided on an "AS IS" basis, without warranties of any kind.

This document and all information discussed herein remain the sole and exclusive property of Samsung Electronics. No license of any patent, copyright, mask work, trademark or any other intellectual property right is granted by one party to the other party under this document, by implication, estoppel or otherwise.

Samsung products are not intended for use in life support, critical care, medical, safety equipment, or similar applications where product failure could result in loss of life or personal or physical harm, or any military or defense application, or any governmental procurement to which special terms or provisions may apply.

For updates or additional information about Samsung products, contact your nearest Samsung office.

All brand names, trademarks and registered trademarks belong to their respective owners.

## 1. DDR4 SDRAM MEMORY ORDERING INFORMATION

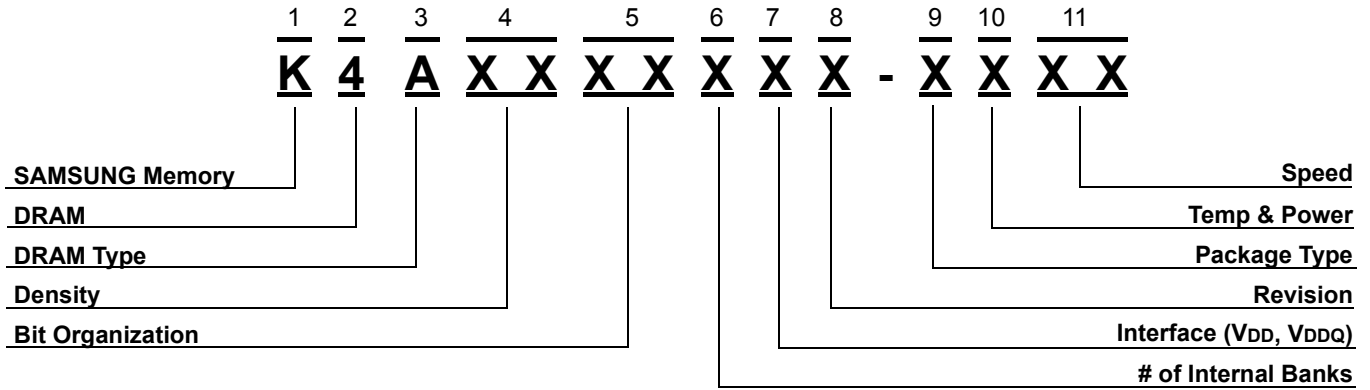

### 1. SAMSUNG Memory : K

### 2. DRAM : 4

### 3. DRAM Type

A : DDR4 SDRAM

### 4. Density

4G : 4Gb  
 8G : 8Gb  
 16G : AG  
 32G : BG

### 5. Bit Organization

04 : x 4  
 08 : x 8

### 6. # of Internal Banks

5 : 16 Banks

### 7. Interface ( VDD, VDDQ)

W : POD (1.2V, 1.2V)

### 8. Revision

M : 1st Gen.  
 A : 2nd Gen.  
 B : 3rd Gen.  
 C : 4th Gen.  
 D : 5th Gen.  
 E : 6th Gen.  
 F : 7th Gen.  
 G : 8th Gen.  
 H : 9th Gen.

### 9. Package Type

B : FBGA (Halogen-free & Lead-free, Flip Chip)  
 M : FBGA (Halogen-free & Lead-free, DDP)  
 4 : FBGA (Halogen-free & Lead-free, TSV 4High)  
 2 : FBGA (Halogen-free & Lead-free, TSV 2High)

### 10. Temp & Power

C : Commercial Temp.( 0°C ~ 85°C) & Normal Power

### 11. Speed

PB : DDR4-2133 (1066MHz @ CL=15, tRCD=15, tRP=15)  
 RC : DDR4-2400 (1200MHz @ CL=17, tRCD=17, tRP=17)  
 RB : DDR4-2133 (1066MHz @ CL=17, tRCD=15, tRP=15)  
 TC : DDR4-2400 (1200MHz @ CL=19, tRCD=17, tRP=17)

## 2. DDR4 SDRAM Component Product Guide

Density	Banks	Part Number	Package & Power, Temp. & Speed	Org.	VDD Voltage	PKG	Avail.	NOTE
4Gb D-die	16Banks (4Bank Groups)	K4A4G045WD	BCPB/RC	1G x 4	1.2V	78 ball FBGA	MP	
		K4A4G085WD	BCPB/RC	512M x 8				
8Gb B-die	16Banks (4Bank Groups)	K4A8G045WB	BCPB/RC	2G x 4	1.2V	78 ball FBGA	MP	
		K4A8G085WB	BCPB/RC	1G x 8				

## 3. DDR4 SDRAM Module Ordering Information

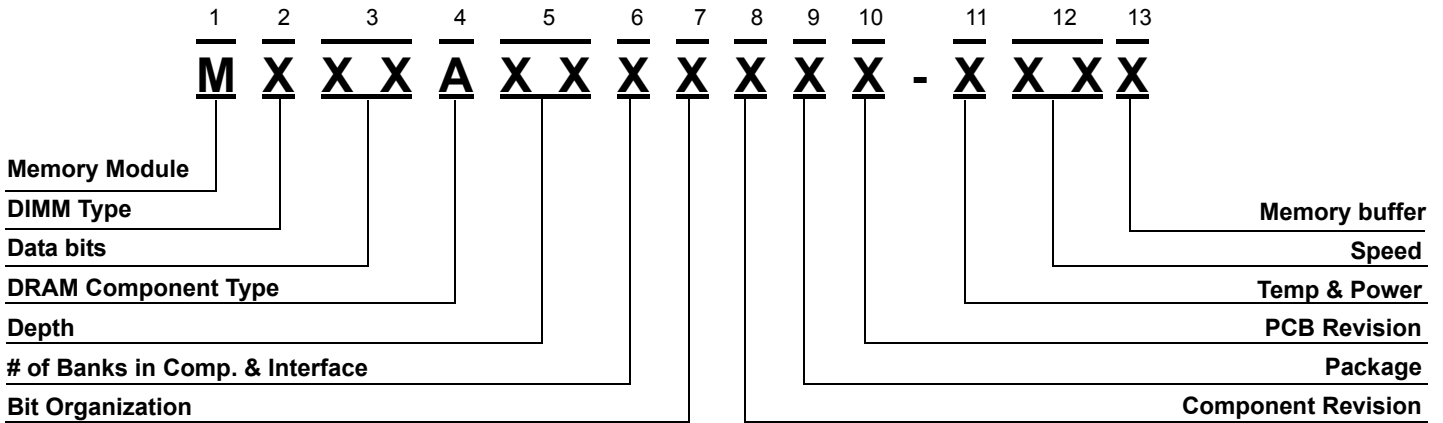

### 1. Memory Module : M

### 2. DIMM Type

- 3 : DIMM
- 4 : SODIMM

### 3. Data Bits

- 71: x64 260pin Unbuffered SODIMM
- 74 : x72 260pin ECC Unbuffered SODIMM
- 78: x64 288pin Unbuffered DIMM
- 86: x72 288pin Load Reduced DIMM
- 91: x72 288pin ECC Unbuffered DIMM
- 92: x72 288pin VLP Registered DIMM
- 93: x72 288pin Registered DIMM

### 4. DRAM Component Type

- A : DDR4 SDRAM (1.2V VDD)

### 5. Depth

- 51K : 512M
- 1G : 1G
- 2G : 2G
- 4G : 4G
- 8G : 8G
- 1K : 1G (for 8Gb)
- 2K : 2G (for 8Gb)
- 4K : 4G (for 8Gb)
- 8K : 8G (for 8Gb)
- AG : 16G

### 6. # of Banks in comp. & Interface

- 4 : 16Banks & POD-1.2V

### 7. Bit Organization

- 0 : x 4
- 3 : x 8

### 8. Component Revision

- M : 1st Gen.
- B : 3rd Gen.
- D : 5th Gen.
- F : 7th Gen.
- A : 2nd Gen.
- C : 4th Gen.
- E : 6th Gen.
- G : 8th Gen.

### 9. Package

- B : FBGA (Halogen-free & Lead-free, Flip Chip)
- M : FBGA (Halogen-free & Lead-free, DDP)
- 2 : FBGA (Halogen-free & Lead-free, 2H TSV)
- 4 : FBGA (Halogen-free & Lead-free, 4H TSV)

### 10. PCB Revision

- 0 : None
- 2 : 2nd Rev.
- 4 : 4th Rev.
- 1 : 1st Rev.
- 3 : 3rd Rev.

### 11. Temp & Power

- C : Commercial Temp.( 0°C ~ 85°C) & Normal Power

### 12. Speed

- PB : DDR4-2133 (1066MHz @ CL=15, tRCD=15, tRP=15)
- RC : DDR4-2400 (1200MHz @ CL=17, tRCD=17, tRP=17)
- RB : DDR4-2133 (1066MHz @ CL=17, tRCD=15, tRP=15)
- TC : DDR4-2400 (1200MHz @ CL=19, tRCD=17, tRP=17)

## 4. DDR4 SDRAM Module Product Guide

## 4.1 288Pin DDR4 Registered DIMM

288Pin DDR4 Registered DIMM													
Org.	Density	Part Number	Speed	Raw Card	Composition	Comp. Version		Internal Banks	Rank	PKG	Height	Avail.	NOTE
1G x72	8GB	M393A1G40DB0	CPB	C(1Rx4)	1G x4 * 18pcs	4Gb	D-die	16	1	78ball FBGA	31.25mm	MP	
1G x72	8GB	M393A1G40DB1	CRC	C(1Rx4)	1G x4 * 18pcs	4Gb	D-die	16	1	78ball FBGA	31.25mm	Mar'15 CS	
1G x72	8GB	M393A1G43DB0	CPB	E(2Rx8)	512M x8 * 18pcs	4Gb	D-die	16	2	78ball FBGA	31.25mm	MP	
1G x72	8GB	M393A1G43DB1	CRC	E(2Rx8)	512M x8 * 18pcs	4Gb	D-die	16	2	78ball FBGA	31.25mm	Apr'15 CS	
2G x72	16GB	M393A2G40DB0	CPB	A(2Rx4)	1G x4 * 36pcs	4Gb	D-die	16	2	78ball FBGA	31.25mm	MP	
2G x72	16GB	M393A2G40DB1	CRC	A(2Rx4)	1G x4 * 36pcs	4Gb	D-die	16	2	78ball FBGA	31.25mm	Mar'15 CS	
2G x72	16GB	M393A2K40BB0	CPB	C(1Rx4)	2G x4 * 18pcs	8Gb	B-die	16	1	78ball FBGA	31.25mm	MP	
2G x72	16GB	M393A2K40BB1	CRC	C(1Rx4)	2G x4 * 18pcs	8Gb	B-die	16	1	78ball FBGA	31.25mm	Mar'15 CS	
2G x72	16GB	M393A2K43BB1	CPB	E(2Rx8)	1G x8 * 18pcs	8Gb	B-die	16	2	78ball FBGA	31.25mm	Mar'15 CS	
			CRC										
4G x72	32GB	M393A4K40BB0	CPB	A(2Rx4)	2G x4 * 36pcs	8Gb	B-die	16	2	78ball FBGA	31.25mm	MP	
4G x72	32GB	M393A4K40BB1	CRC	A(2Rx4)	2G x4 * 36pcs	8Gb	B-die	16	2	78ball FBGA	31.25mm	MP	
8G x72	64GB	M393A8G40D40	CRB	A(8Rx4)	4H TSV 4G x4 * 36pcs	4Gb	D-die	16	8	78ball FBGA	31.25mm	MP	
8G x72	64GB	TBD	CRB/CTC	A(4Rx4)	2H TSV 4G x4 * 36pcs	8Gb	B-die	16	4	78ball FBGA	31.25mm	Aug'15 CS	
16G x72	128GB	TBD	CRB/CTC	A(8Rx4)	4H TSV 8G x4 * 36pcs	8Gb	B-die	16	8	78ball FBGA	31.25mm	Dec'15 CS	

## 4.2 288Pin DDR4 Load Reduced DIMM

288Pin DDR4 Load Reduced DIMM													
Org.	Density	Part Number	Speed	Raw Card	Composition	Comp. Version		Internal Banks	Rank	PKG	Height	Avail.	NOTE
4G x72	32GB	M386A4G40DM0	CPB	D(4Rx4)	DDP 2G x4 * 36pcs	4Gb	D-die	16	4	78ball FBGA	31.25mm	MP	
4G x72	32GB	M386A4G40DM1	CRC	D(4Rx4)	DDP 2G x4 * 36pcs	4Gb	D-die	16	4	78ball FBGA	31.25mm	May'15 CS	
8G x72	64GB	M386A8K40BM1	CPB	D(4Rx4)	DDP 4G x4 * 36pcs	8Gb	B-die	16	4	78ball FBGA	31.25mm	Mar'15 CS	
			CRC										

## 4.3 288Pin DDR4 VLP Registered DIMM

288Pin DDR4 VLP Registered DIMM													
Org.	Density	Part Number	Speed	Raw Card	Composition	Comp. Version		Internal Banks	Rank	PKG	Height	Avail.	NOTE
2G x72	16GB	M392A2G40DM0	CPB	J(2Rx4)	DDP 2G x4 * 18pcs	4Gb	D-die	16	2	78ball FBGA	18.75mm	MP	
2G x72	16GB	TBD	CPB	H(2Rx8)	1G x8 * 18pcs	8Gb	B-die	16	2	78ball FBGA	18.75mm	Oct'15 CS	
			CRC										
4G x72	32GB	M392A4K40BM0	CPB	J(2Rx4)	DDP 4G x4 * 18pcs	8Gb	B-die	16	2	78ball FBGA	18.75mm	July'15 CS	
			CRC										

## 4.4 260Pin DDR4 ECC SODIMM

260Pin DDR4 ECC SODIMM													
Org.	Density	Part Number	Speed	Raw Card	Composition	Comp. Version		Internal Banks	Rank	PKG	Height	Avail.	NOTE
1G x72	8GB	M474A1G43DB0	CPB	G(2Rx8)	512M x8 * 18pcs	4Gb	D-die	16	2	78ball FBGA	30mm	MP	
1G x72	8GB	M474A1G43DB1	CRC	G(2Rx8)	512M x8 * 18pcs	4Gb	D-die	16	2	78ball FBGA	30mm	May'15 CS	
2G x72	16GB	M474A2K43BB1	CPB	G(2Rx8)	1G x8 * 18pcs	8Gb	B-die	16	2	78ball FBGA	30mm	Mar'15 CS	
			CRC										

## 4.5 260Pin DDR4 Non ECC SODIMM

260Pin DDR4 Non ECC SODIMM													
Org.	Density	Part Number	Speed	Raw Card	Composition	Comp. Version		Internal Banks	Rank	PKG	Height	Avail.	NOTE
512M x64	4GB	M471A5143DB0	CPB	A(1Rx8)	512M x8 * 8pcs	4Gb	D-die	16	1	78ball FBGA	30mm	MP	
512M x64	4GB	M471A5143EB0	CPB	A(1Rx8)	512M x8 * 8pcs	4Gb	E-die	16	1	78ball FBGA	30mm	July'15 CS	
			CRC										
1G x64	8GB	M471A1G43DB0	CPB	E(2Rx8)	512M x8 * 16pcs	4Gb	D-die	16	2	78ball FBGA	30mm	MP	
1G x64	8GB	M471A1K43BB0	CPB	A(1Rx8)	1G x8 * 8pcs	8Gb	B-die	16	1	78ball FBGA	30mm	July'15 CS	
			CRC										
2G x64	16GB	M471A2K43BB1	CPB	E(2Rx8)	1G x8 * 16pcs	8Gb	B-die	16	2	78ball FBGA	30mm	MP	
			CRC										

## 4.6 288Pin DDR4 ECC UDIMM

288Pin DDR4 ECC UDIMM													
Org.	Density	Part Number	Speed	Raw Card	Composition	Comp. Version		Internal Banks	Rank	PKG	Height	Avail.	NOTE
1G x72	8GB	M391A1G43DB0	CPB	E(2Rx8)	512M x8 * 18pcs	4Gb	D-die	16	2	78ball FBGA	31.25mm	MP	
1G x72	8GB	M391A1G43DB1	CRC	E(2Rx8)	512M x8 * 18pcs	4Gb	D-die	16	2	78ball FBGA	31.25mm	Mar'15 CS	
2G x72	16GB	M391A2K43BB1	CPB	E(2Rx8)	1G x8 * 18pcs	8Gb	B-die	16	2	78ball FBGA	31.25mm	Mar'15 CS	
			CRC										

## 4.7 288Pin DDR4 Non ECC UDIMM

288Pin DDR4 Non ECC UDIMM													
Org.	Density	Part Number	Speed	Raw Card	Composition	Comp. Version		Internal Banks	Rank	PKG	Height	Avail.	NOTE
512M x64	4GB	M378A5143DB0	CPB	A(1Rx8)	512M x8 * 8pcs	4Gb	D-die	16	1	78ball FBGA	31.25mm	MP	
512M x64	4GB	M378A5143EB1	CPB CRC	A(1Rx8)	512M x8 * 8pcs	4Gb	E-die	16	1	78ball FBGA	31.25mm	July'15 CS	
1G x64	8GB	M378A1G43DB0	CPB	B(2Rx8)	512M x8 * 16pcs	4Gb	D-die	16	2	78ball FBGA	31.25mm	MP	
1G x64	8GB	M378A1K43BB1	CPB CRC	A(1Rx8)	512M x8 * 8pcs	8Gb	B-die	16	1	78ball FBGA	31.25mm	July'15 CS	
2G x64	16GB	M378A2K43BB1	CPB CRC	B(2Rx8)	1G x8 * 16pcs	8Gb	B-die	16	2	78ball FBGA	31.25mm	MP	

## 5. RDIMM, LRDIMM Memory Buffer Information

### 5.1 Label Example

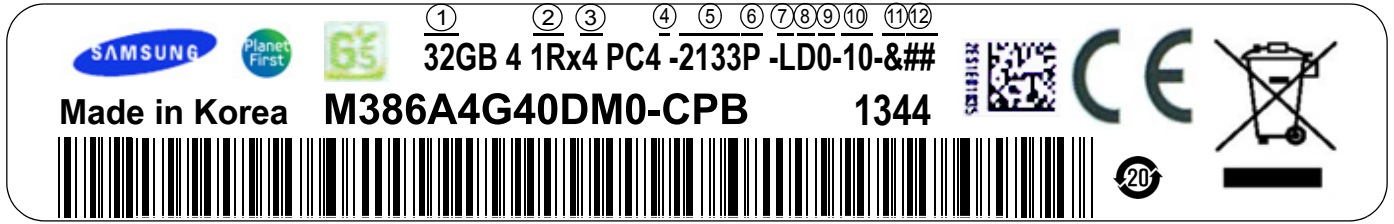

### 5.2 JEDEC Description Information

1. Module total capacity, in gigabytes, for primary bus (ECC not counted)
2. Number of package ranks of memory installed and number of logical ranks per package rank
3. Device organization (data bit width) of SDRAMs used on this assembly
4. SDRAM and support component supply voltage (VDD)  
blank = 1.2 V operable
5. Module speed in Mb/s/data pin
6. SDRAM speed grade
7. Module Type  
 E = Unbuffered DIMM ("UDIMM"), x64 primary + 8 bit ECC module data bus  
 L = Load Reduced DIMM ("LRDIMM"), x64 primary + 8 bit ECC module data bus  
 R = Registered DIMM ("RDIMM"), x64 primary + 8 bit ECC module data bus  
 S = Small Outline DIMM ("SO-DIMM"), no ECC (x64 bit module data bus)  
 U = Unbuffered DIMM ("UDIMM"), no ECC (x64 bit module data bus)  
 T = Unbuffered 72-bit small outline DIMM ("72b-SO-DIMM"), x64 primary + 8bit ECC module data bus
8. Reference design file used for this design (if applicable)  
 A = Reference design for raw card 'A' is used for this assembly  
 B = Reference design for raw card 'B' is used for this assembly  
 AC = Reference design for raw card 'AC' is used for this assembly (example only)  
 ZZ = None of the JEDEC standard reference designs were used for this assembly
9. Revision number of the reference design used  
 0 = Initial release  
 1 = First revision  
 2 = Second revision  
 P = Pre-release or Engineering sample  
 Z = To be used when reference raw card = ZZ
10. JEDEC SPD Revision Encoding and Additions level used on this DIMM

### 5.3 RCD (& Data Buffer) Information

(These codes are only used SAMSUNG, Not JEDEC)

11&12. RCD, Data Buffer Revision & Vendor used on this DIMM

Jedec description on label	Buffer Vendor	RCD ver	DB ver (Only LRDIMM)
DC0	IDT	C0	B1
MB1	Montage	B1	A1
MC0	Montage	C0	B0
DC3	IDT	C0	A3
P20	Inphi	GS02	GS01



## 6. Package Dimension

78ball FPGA for 4Gb D-die (x4/x8)/DDP 8Gb D-die (x4)/4H 16Gb D-die (x4)/4Gb E-die (x4/x8)/ 8Gb B-die (x4/x8)/DDP 16Gb B-die (x4)/2H 16Gb B-die (x4)/4H 32Gb B-die (x4)

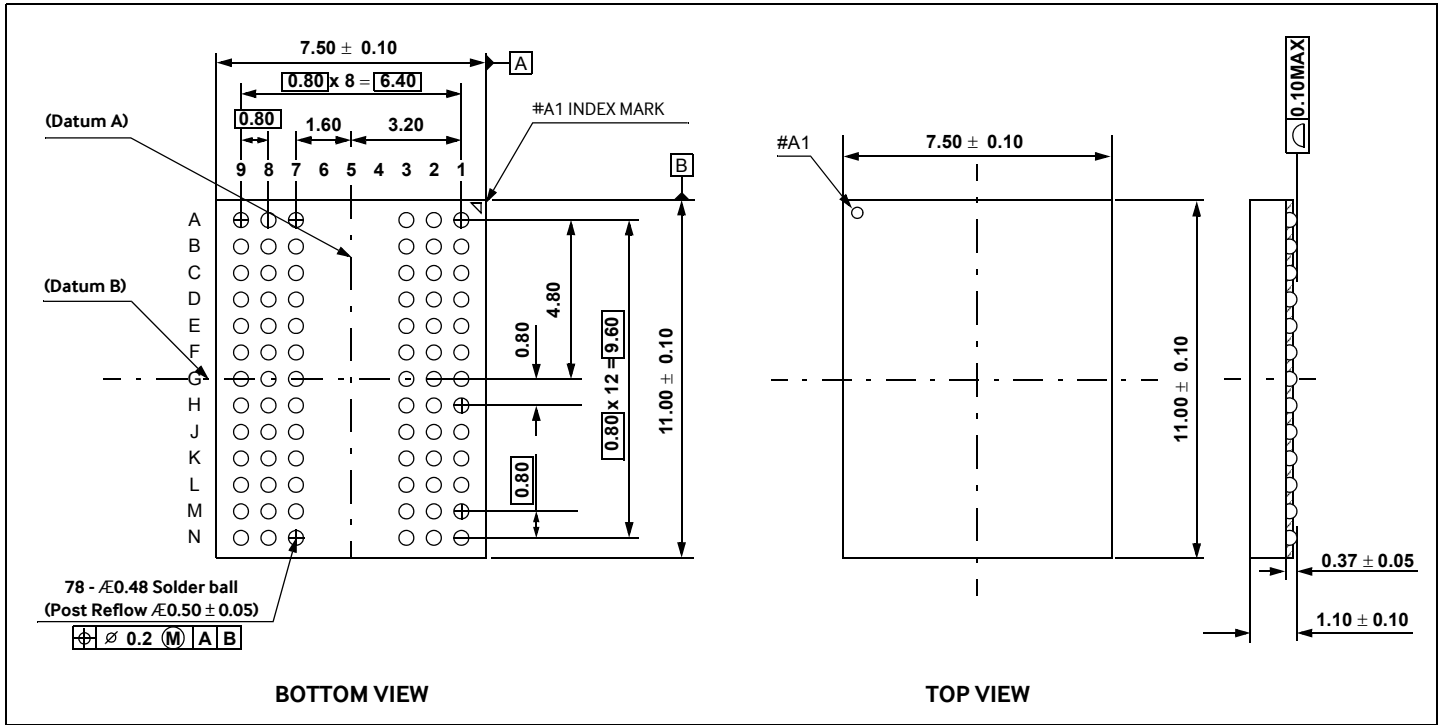

## 7. Module Dimension

- x72 288pin DDR4 SDRAM RDIMM
- x72 288pin DDR4 SDRAM LRDIMM
- x72 288pin DDR4 SDRAM ECC UDIMM
- x64 288pin DDR4 SDRAM Non ECC UDIMM

Units : Millimeters

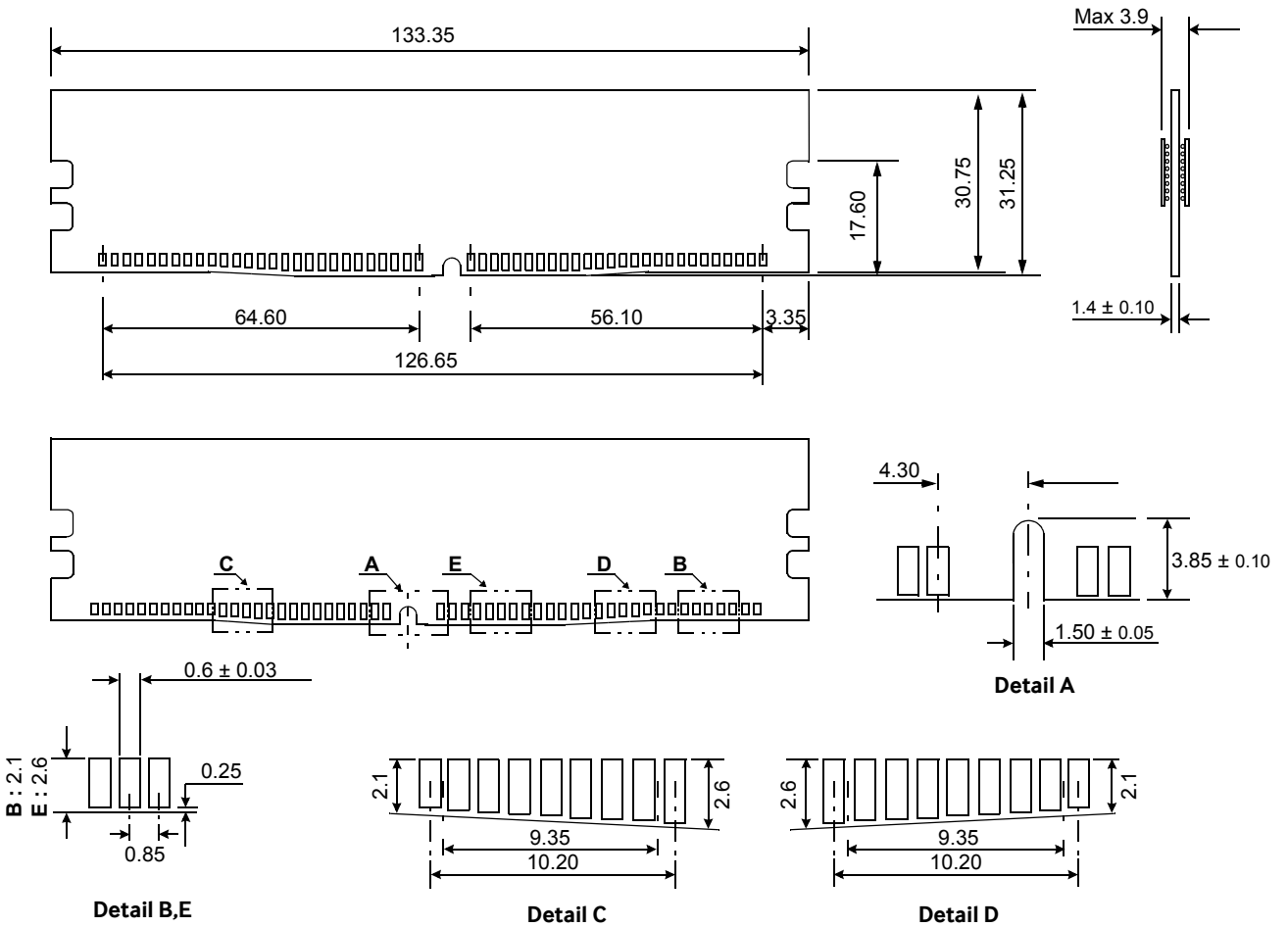

x72 260pin DDR4 SDRAM ECC SODIMM  
x64 260pin DDR4 SDRAM Non ECC SODIMM

Units : Millimeters

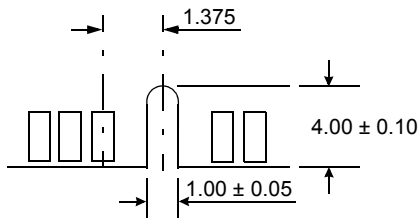
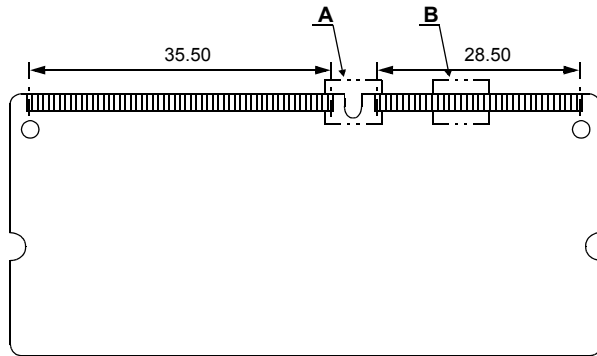
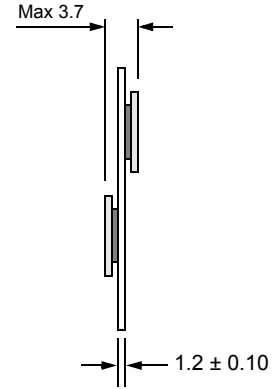
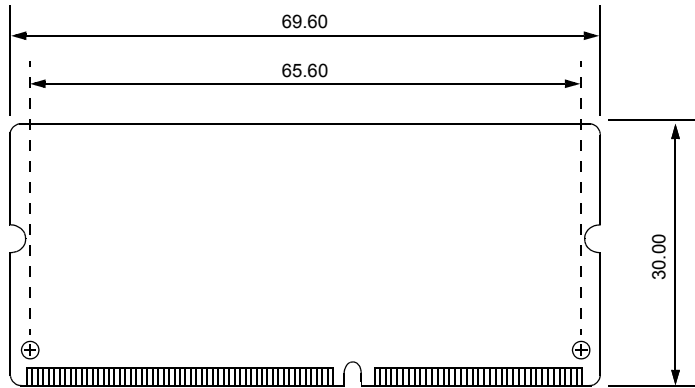

Detail A

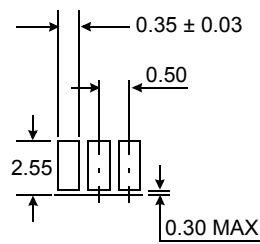

Detail B

## x72 288pin DDR4 VLP Registered DIMM

Units : Millimeters

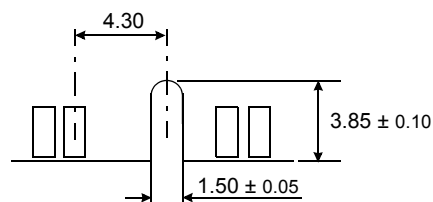
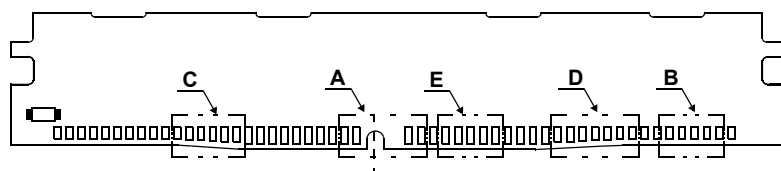
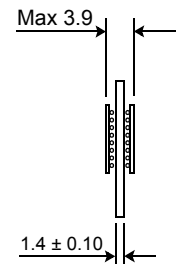
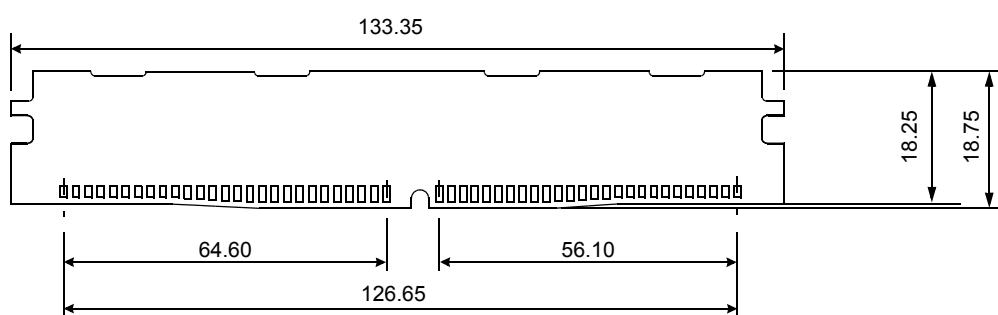

Detail A

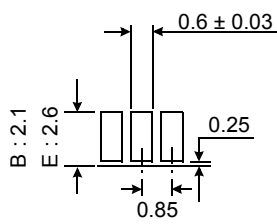

Detail B,E

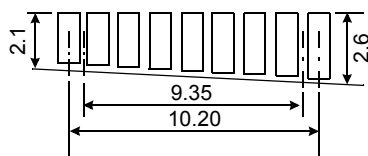

Detail C

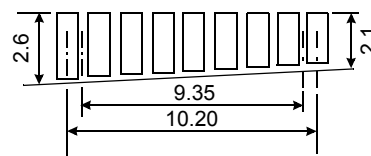

Detail D

## VLP Registered DIMM Heat Spreader Design Guide (DDP)

### 1. FRONT

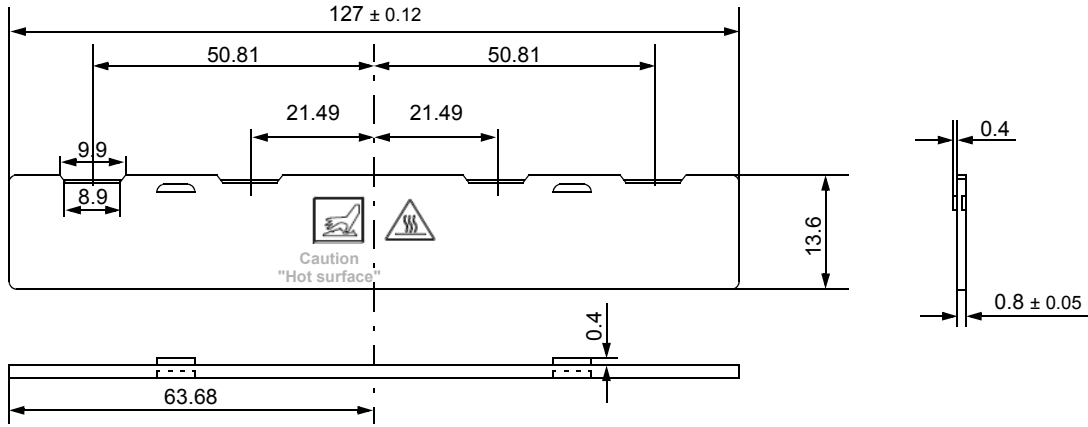

### 2. BACK

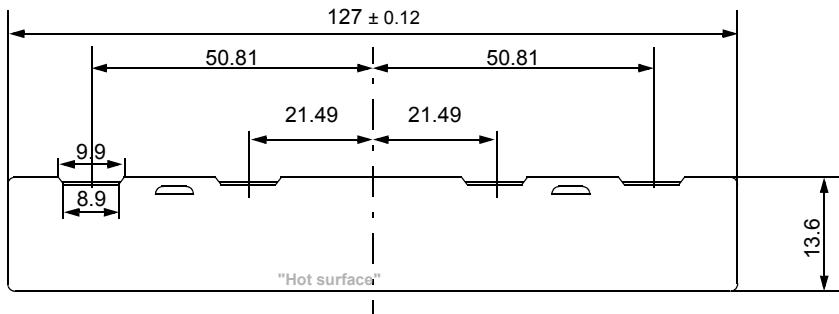

### 3. CLIP

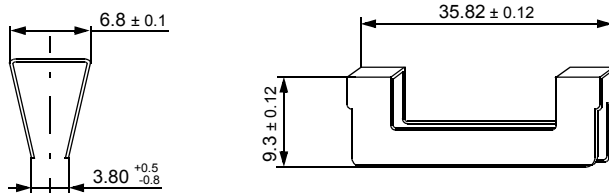

## TSV Registered DIMM Heat Spreader Design Guide

### 1. FRONT PART

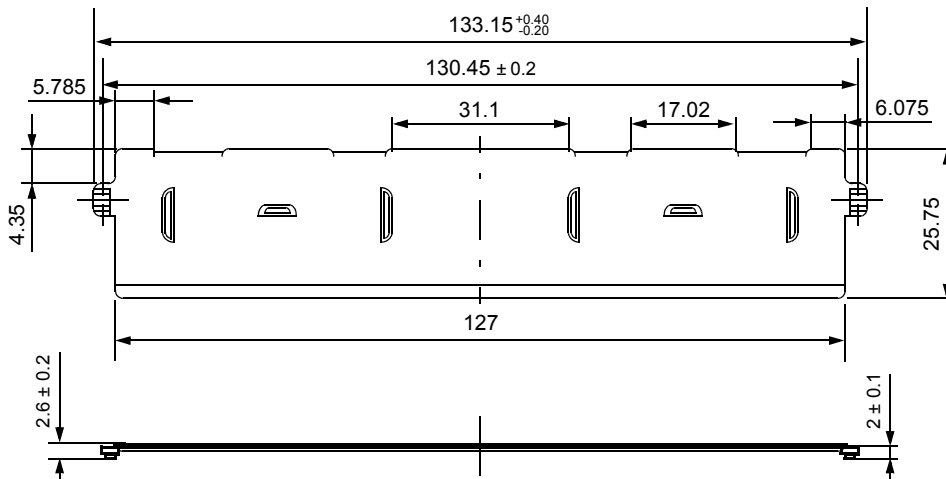

### 2. BACK PART

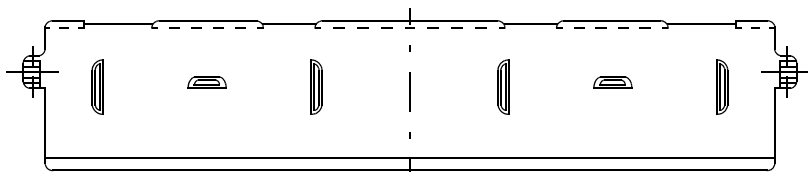

### 3. CLIP PART

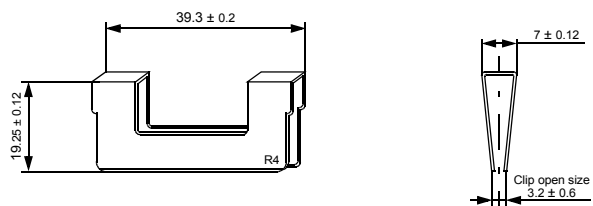

## LRDIMM Heat Spreader Design Guide

### 1. FRONT PART

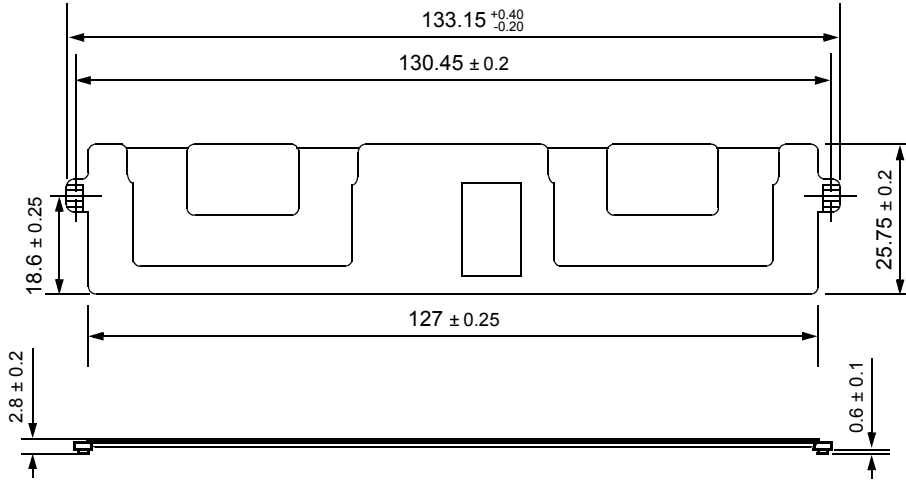

### 2. BACK PART



### 3. CLIP PART

